

FLAT GLASS PROCESSING MACHINES

— One Stop Solution —

DEMAN

TABLE OF CONTENT

HORIZONTAL GRINDING

DOUBLE-SIDED C-EDGE GRINDING MACHINE	08
THIN GLASS DOUBLE-SIDED C-EDGE GRINDING MACHINE	10
SHAPED GLASS & ROUND CORNER DOUBLE-SIDED C-EDGE GRINDING MACHINE	11
VACUUM C-EDGE GRINDING MACHINE	12
SMALL GLASS C-EDGE COMBI MACHINE	13
FULLY AUTOMATIC C-EDGE GRINDING MACHINE	14
DOUBLE-SIDED T-EDGE GRINDING MACHINE	16
NEW GENERATION T-EDGE GRINDING MACHINE	18

HORIZONTAL DRILLING

STANDALONE DRILLING MACHINE	22
AUTOMATIC IN-LINE DRILLING MACHINE	24
AUTOMATIC IN-PARALLEL DRILLING MACHINE	25
AUTOMATIC IN-LINE DRILLING & MILLING MACHINE	26
AUTOMATIC IN-LINE VACUUM DRILLING MACHINE	27
FULLY AUTOMATIC IN-LINE HEAVY-DUTY DRILLING MACHINE	28
FULLY AUTOMATIC IN-LINE HEAVY-DUTY CNC MACHINE	29

HORIZONTAL WASHING

PHOTOVOLTAIC GLASS 32
WASHING MACHINE

ARCHITECTURAL GLASS 33
WASHING MACHINE

PATTERNED GLASS 34
ACID ETCHING MACHINE

WATER CIRCULATION 35
TREATMENT SYSTEM

NEW GENERATION 36
WASHING MACHINE

VERTICAL PROCESSING

VERTICAL 40
GRINDING MACHINE

VERTICAL 41
SEAMING MACHINE

VERTICAL 42
DRILLING MACHINE

VERTICAL 43
CNC MACHINE

VERTICAL 44
WASHING MACHINE

VERTICAL 45
TURNING TABLE

CONVEYING & HANDLING

AUTOMATIC 48
TRANSPORT SYSTEM

ROBOTIC 49
LOADER/UNLOADER

AUTOMATIC GANTRY 50
LOADER/UNLOADER

AUTOMATIC TURNOVER 51
LOADER/UNLOADER

PRODUCTION 52
LINE

ABOUT DEMAN

Zhejiang Deman Machine Co., Ltd. is a leading Chinese-German joint venture specializing in flat glass cold processing machinery. Our dedicated R&D team continuously innovates to meet market demands, delivering tailored solutions for each customer. By combining competitive pricing with advanced technology, strict production control, and exceptional service, we provide high-quality and extremely reliable machinery.



Our key products include C- & T-Edge Grinding Machines, Automatic Drilling Machines, Glass CNC/Water Jet Systems, Glass Washing Machines, Loading/Unloading Devices and complete Flat Glass Processing Lines. Designed for high precision, efficiency and durability, our equipment is easy to operate and maintain. Choose DEMAN for robust and cost-effective glass processing solutions.



HORIZONTAL GRINDING MACHINES





DOUBLE-SIDED C-EDGE GRINDING MACHINE

Our double edger features an innovative grinding head design that ensures hassle-free and quick replacement of grinding & polishing wheels and optimizes overall production efficiency.

Its sliding tables are produced through iron casting in one seamless piece, ensuring unparalleled stability during operation, enhancing precision and reliability, making it an ideal choice for demanding glass processing tasks where accuracy is paramount.

SPECIFICATION

Speed:	0-30m/min
Glass thickness:	2-8mm
Minimal glass size:	150(W) x 100mm(L) (grinding) 300(W) x 250mm(L) (corner cutting)
Maximal glass size:	3600(W) x 2500mm(L)
Size tolerance:	$\pm 0.2\text{mm}$
Diagonal tolerance:	$\pm 0.5\text{mm/m}$
Groove width:	2.5-5mm
Groove depth:	up to 0.8mm

OPTIONAL



CORNER CUTTING

APPLICATION

Solar glass
Home appliances glass
Furniture glass

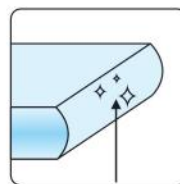

Pencil-Polished

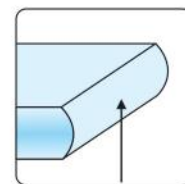

Pencil-Grinded



DEMAN Grind Tech

THIN GLASS DOUBLE-SIDED C-EDGE GRINDING MACHINE



Our thin glass grinding machine excels in polishing and grinding industrial glass, and is specifically designed to be suitable for photovoltaic and solar panel glass. It ensures smooth, high-quality finishes that meet the stringent standards of the renewable energy industry. With advanced technology and robust construction, it provides reliable performance and durability for large-scale production needs.

SPECIFICATION

Speed:	0-6m/min
Glass thickness:	0.4-4mm
Minimal glass size:	80(W) x 100mm(L)
Maximal glass size:	1200(W) x 2000mm(L)
Size tolerance:	$\pm 0.1\text{mm}$
Diagonal tolerance:	$\pm 0.2\text{mm/m}$

OPTIONAL

Corner cutting device

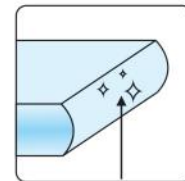

Pencil-Polished

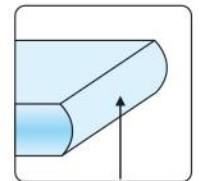

Pencil-Grinded

APPLICATION

Industrial glass
Solar glass



SHAPED GLASS & ROUND CORNER DOUBLE-SIDED C-EDGE GRINDING MACHINE



We have developed a grinding system with a dual servo-tracking capability, which enables double-sided special-shaped edging and round corner processing of glass during transport. This machine significantly enhances production efficiency and reduces costs compared to CNC edgers. Its advanced design ensures precise, high-quality finishes while streamlining the manufacturing process.

SPECIFICATION

Speed:	0-6m/min
Glass thickness:	2-8mm
Round-Corner:	R2-R35
Minimal glass size:	350(W) x 300mm(L)
Maximal glass size:	2500(W) x 2500mm(L)
Size tolerance:	$\pm 0.2\text{mm}$
Diagonal tolerance:	$\pm 0.5\text{mm/m}$

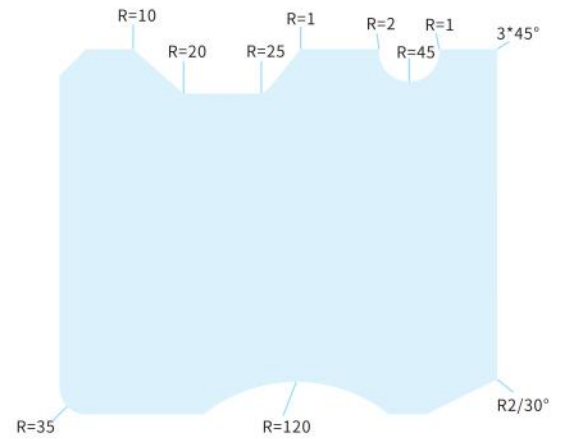

APPLICATION

- Industrial glass
- Display glass
- Home appliances glass
- Furniture glass

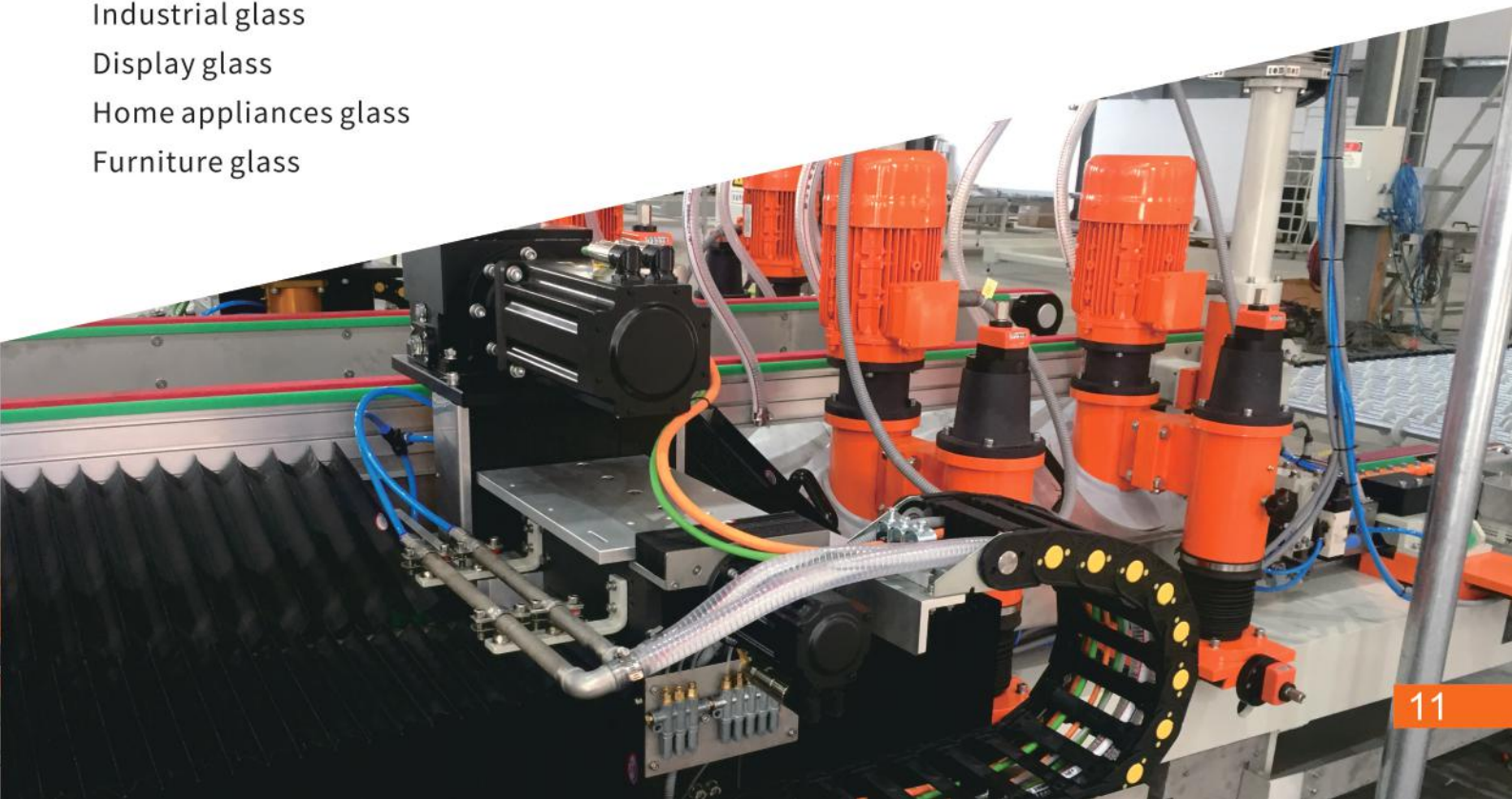

VACUUM C-EDGE GRINDING MACHINE

This double edger, featuring a vacuum waste material absorption function, enables glass edge processing without the use of water. This advanced technology minimizes dust and debris, ensuring a clean and efficient work environment. Ideal for precision grinding and polishing, it consistently delivers high-quality edge finishes while enhancing overall operational efficiency.

SPECIFICATION

Speed:	0-8m/min
Glass thickness:	3-8mm
Minimal glass size:	300mm
Maximal glass size:	3000mm
Size tolerance:	$\pm 0.2\text{mm}$
Diagonal tolerance:	$\pm 0.5\text{mm/m}$

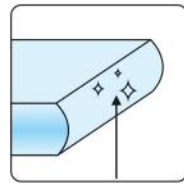

Pencil-Polished

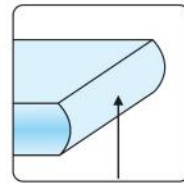

Pencil-Grinded

APPLICATION

Industrial glass
Display glass

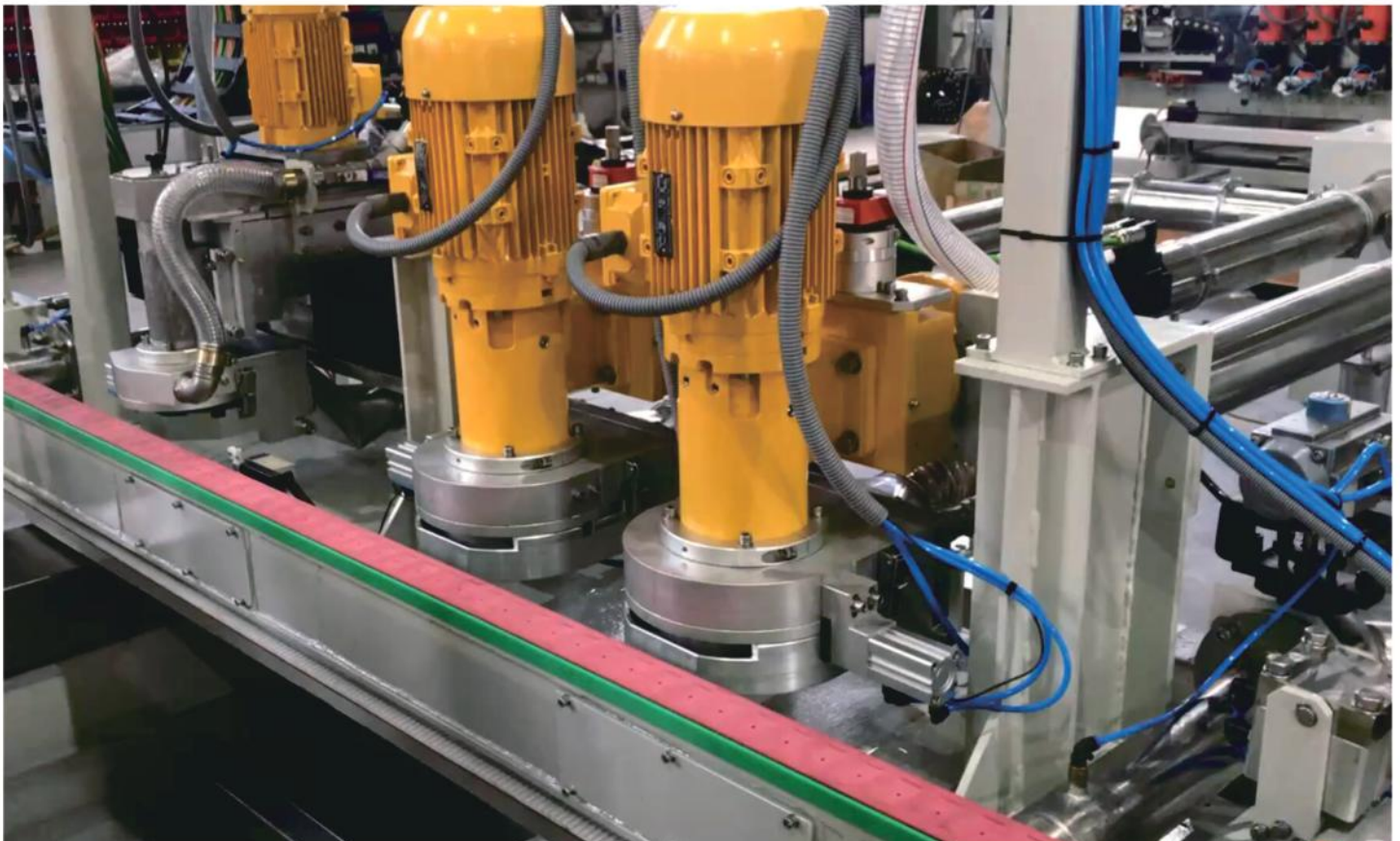

SMALL GLASS C-EDGE COMBI MACHINE

Our round and straight edge integrated grinding machine is ideal for small-sized glass production. With a focus on grinding, it handles glass as narrow as 58mm width, ensuring consistently high-quality finished edges.

SPECIFICATION

Speed:	0-8m/min
Glass thickness:	3-25mm
Minimal glass size:	58mm
Maximal glass size:	250mm
Size tolerance:	$\pm 0.2\text{mm}$
Diagonal tolerance:	$\pm 0.5\text{mm/m}$

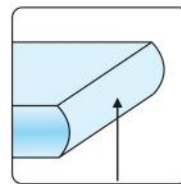

Pencil-Grinded

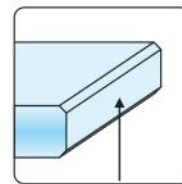

Flat-Grinded

APPLICATION

Industrial glass
Display glass
Furniture glass
Lighting glass



FULLY AUTOMATIC C-EDGE GRINDING MACHINE



SPECIFICATION

Speed:	0-18m/min
Glass thickness:	2-8mm
Minimal glass size:	150(W) x 100mm(L) (grinding) 300(W) x 250mm(L) (corner cutting)
Maximal glass size:	3600(W) x 2500mm(L)
Size tolerance:	$\pm 0.2\text{mm}$
Diagonal tolerance:	$\pm 0.5\text{mm/m}$

APPLICATION

Solar glass
Home appliances glass
Furniture glass

OPTIONAL

Corner cutting device

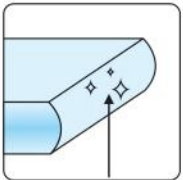

Pencil-Polished

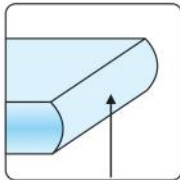

Pencil-Grinded

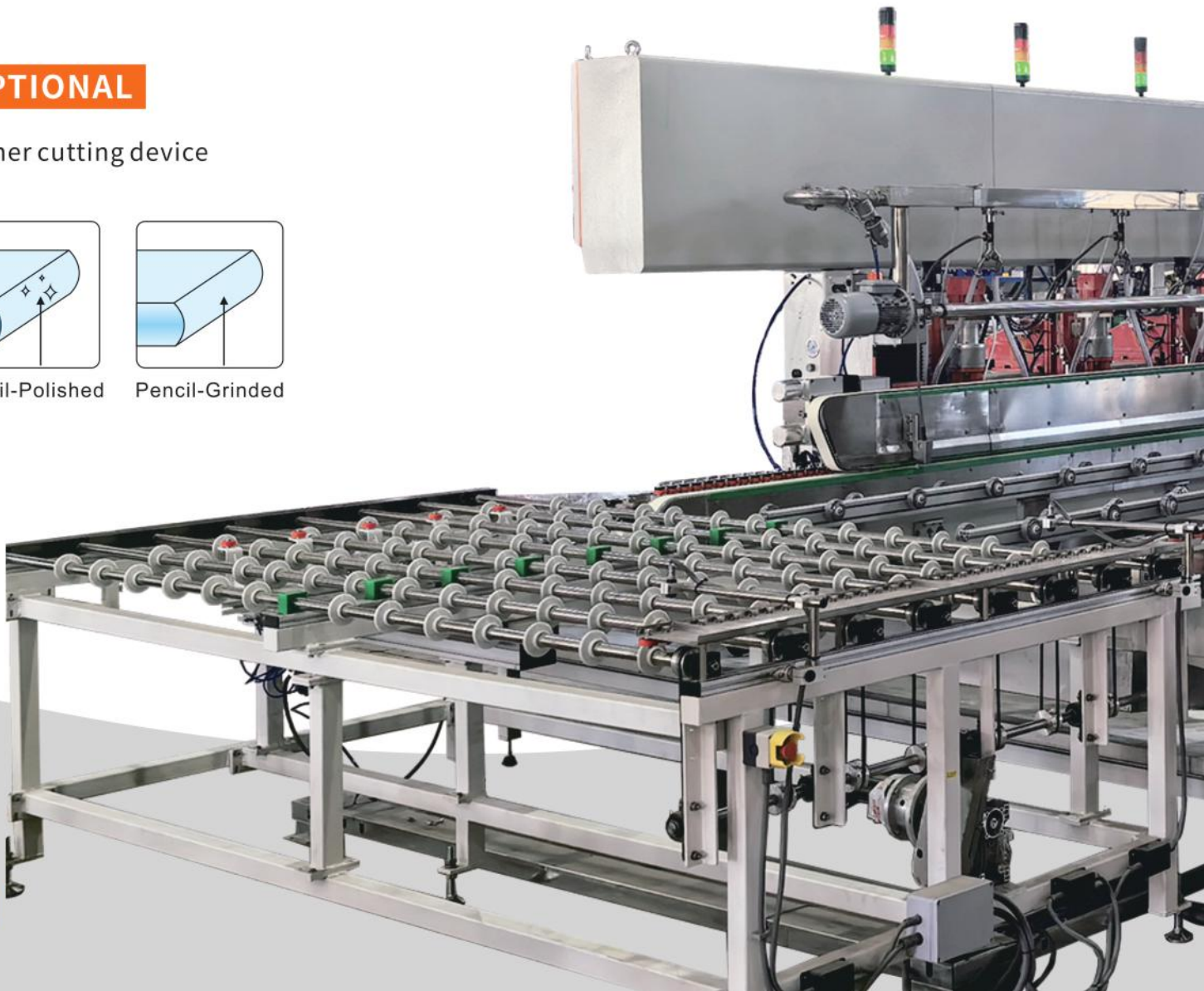

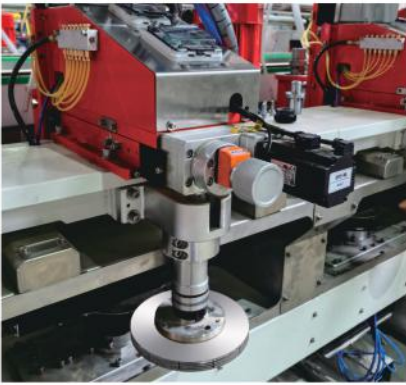

AUTOMATIC TOOL CHANGER

This innovative tool changer system for 4 glass thicknesses enables rapid swapping of grinding wheels, minimizing manual intervention and downtime. Utilizing robotic technology, it ensures seamless transitions, precise alignment, and automatic calibration.



ENERGY EFFICIENT GRINDING

Each fully automatic grinding machine can be equipped with 4 to 8 grinding spindles, featuring built-in polishing function and an optional corner cutting station. Powered by energy-efficient permanent magnet motors, these spindles ensure optimal performance while consuming minimal power.



CENTRAL PROCESS CONTROL

This centralized station oversees grinding processes for single or multiple lines, offering real-time monitoring of vital features and systems such as:

- Glass size control with automatic adjustment of grinding parameters;
- Automatic positioning and correction function;
- Low-energy operation mode;
- Process water pressure control with automatic cleaning of the cooling pipes.



**STANDARD MODEL WITH
CORNER CUTTING DEVICE**



**LARGE GLASS MODEL WITH
AUTOMATIC SIZE ADJUSTMENT**



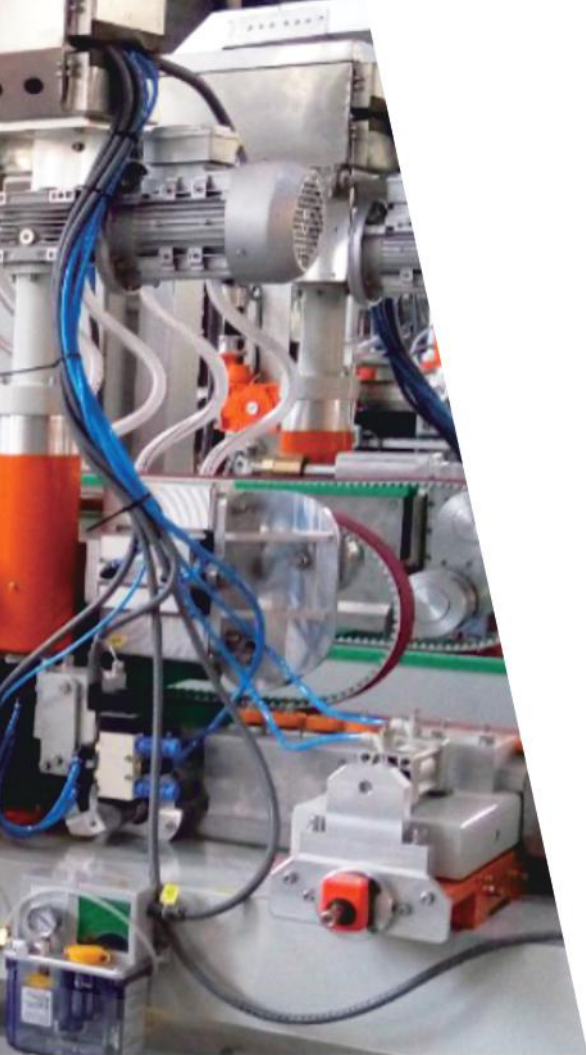

DOUBLE-SIDED T-EDGE GRINDING MACHINE

We have engineered this machine to deliver precision and efficiency in grinding and polishing flat edges on glass panels. The model with an automatic size adjustment function allows for seamless production of multiple glass sizes simultaneously or in small batches.

SPECIFICATION

Speed:	0-8m/min
Glass thickness:	3-25mm
Minimal glass size:	300(W) x 250mm(L)
Maximal glass size:	6500(W) x 3200mm(L)
Tolerance:	$\pm 0.5\text{mm/m}$



OPTIONAL

Corner cutting device
Automatic adjustment of
processing width & thickness
Barcode input function

APPLICATION

Architectural glass
Furniture glass
Partitions glass
Shower glass

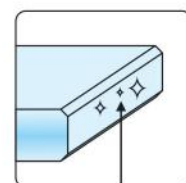

Flat-Polished

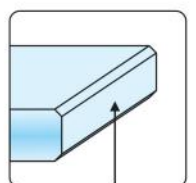

Flat-Grinded

NEW GENERATION T-EDGE GRINDING MACHINE



Introducing the next-generation Flat Edge Double Edger, a versatile T-edge grinding machine designed to accommodate a wide range of glass sizes, from small to large. Featuring precise servo-driven width and thickness adjustments, this advanced machine adapts seamlessly to each glass piece using an integrated barcode scanner for automated input recognition. Ideal for flat glass grinding and polishing, it ensures high-quality finishes and can be effortlessly integrated into a comprehensive processing line with other equipment.



SPECIFICATION

Speed:	0-15m/min
Glass thickness:	3-25mm
Minimal glass size:	300(W) x 250mm(L)
Maximal glass size:	6500(W) x 3200mm(L)
Tolerance:	± 0.5mm/m

APPLICATION

Architectural glass
Furniture glass
Partitions glass
Shower glass

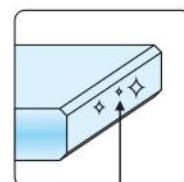

Flat-Polished

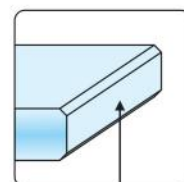

Flat-Grinded

HORIZONTAL DRILLING MACHINES



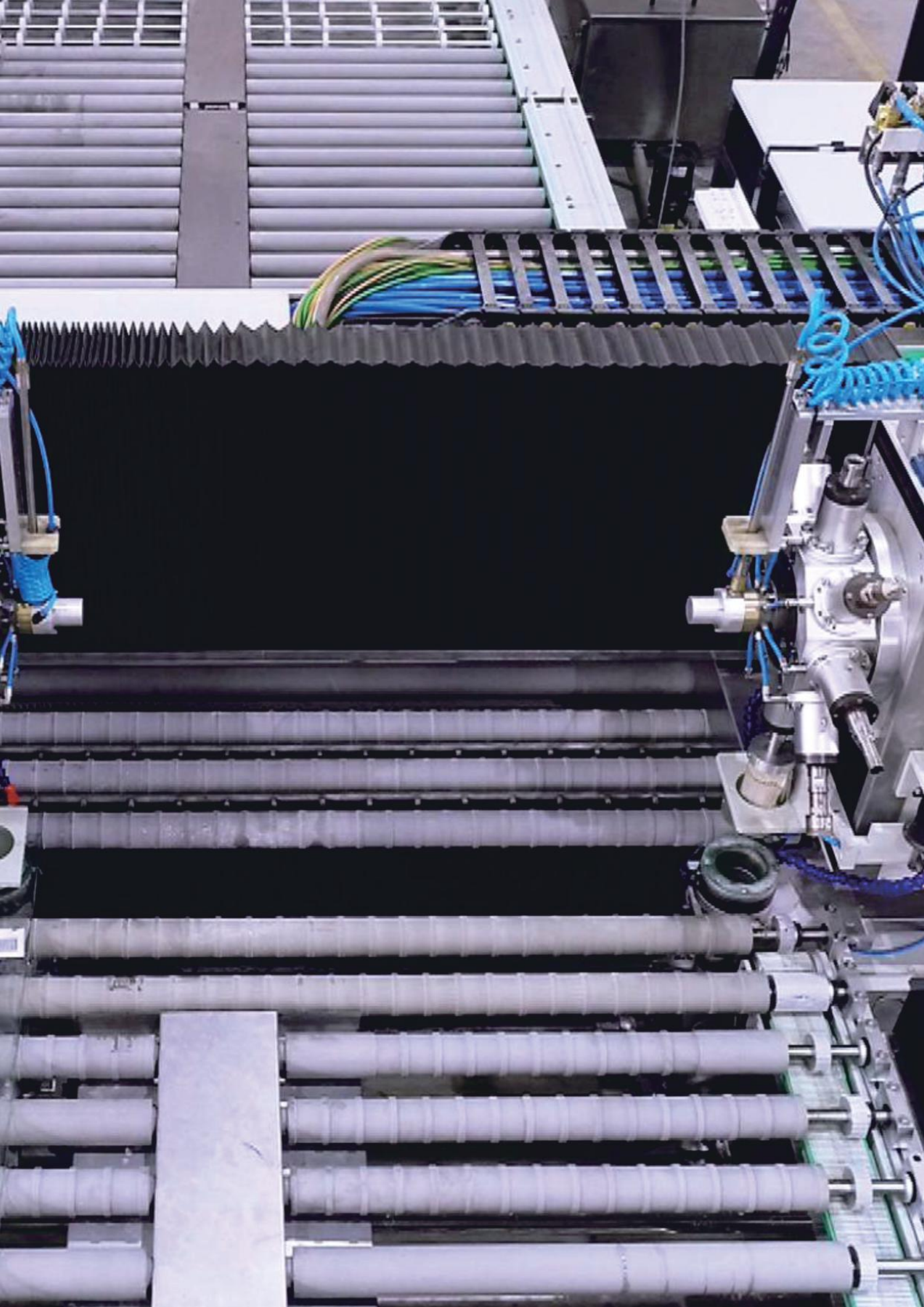

STANDALONE DRILLING MACHINE



Introducing our high-precision standalone glass drilling machine, capable of reaching drilling speeds up to 13000 RPM. This versatile machine excels at both drilling precise holes and grinding outer edges with exceptional accuracy. Choose between a single-head configuration or enhance performance with options featuring up to four drilling heads. Each head is available in single-tool, double-tool, or rotary types, accommodating either 4 or 8 tool holders for maximum flexibility. Designed as a standalone solution, our glass drilling machine delivers unmatched speed, versatility, and precision to meet all your glassworking needs.

SPECIFICATION

Glass thickness:	2-25mm
Minimal glass size:	50(W) x 300mm(L)
Maximal glass size:	2000(W) x 3000mm(L)
Hole size:	ϕ 4-65mm
Tolerance of hole size:	\pm 0.2mm
Tolerance of hole position:	\pm 0.3mm
Drilling cycle:	10-30s

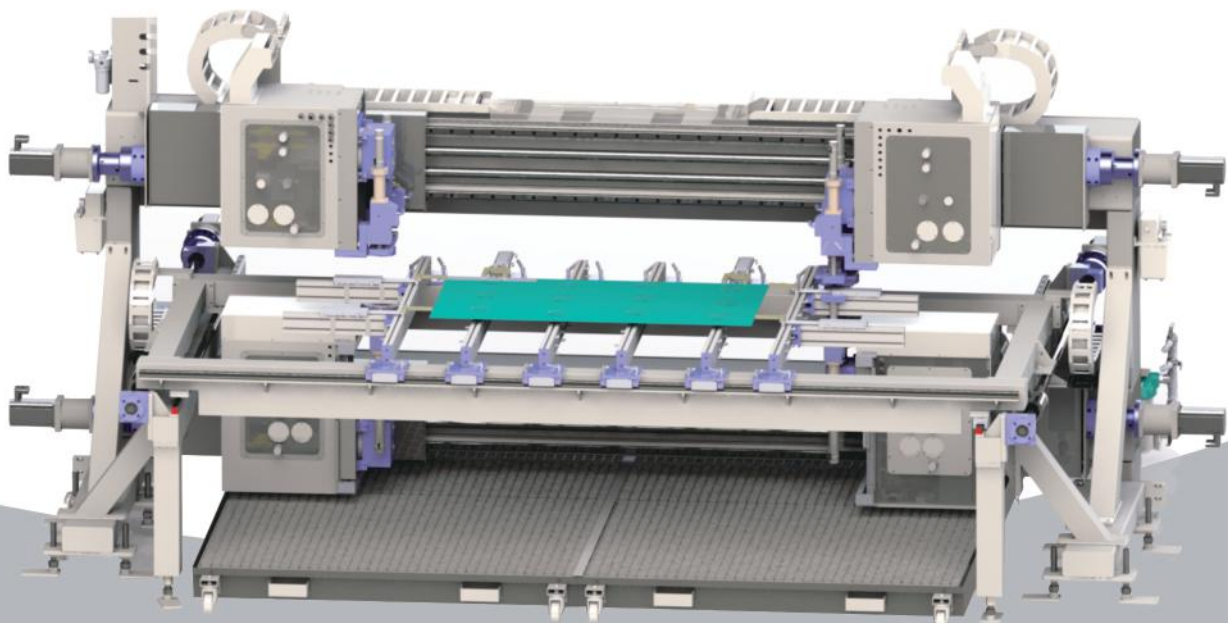

DOUBLE-HEAD/SINGLE-TOOL

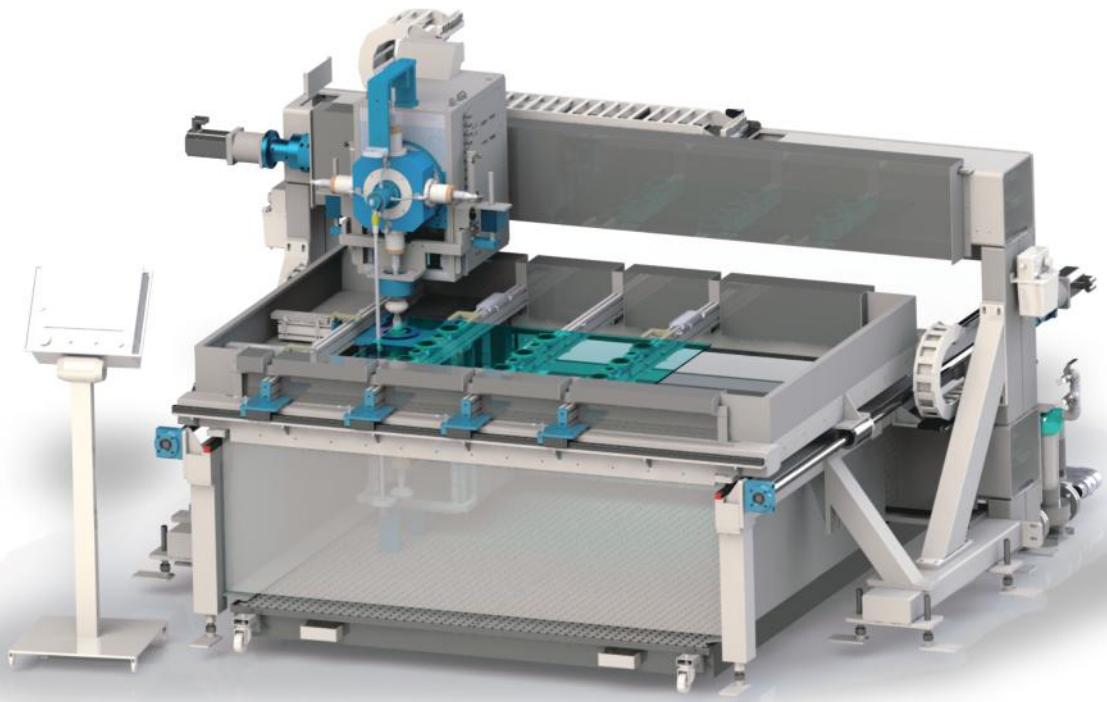

ROTARY-HEAD/FOUR-TOOL

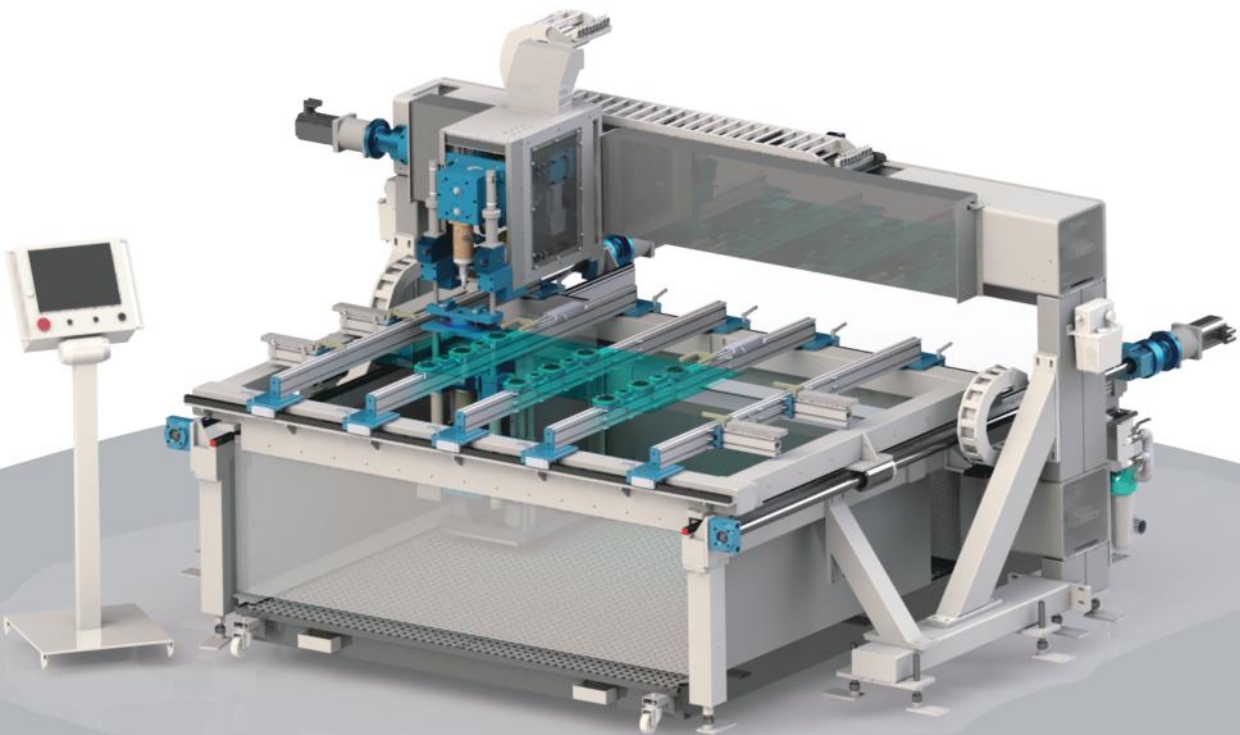

SINGLE-HEAD/SINGLE-TOOL

AUTOMATIC IN-LINE DRILLING MACHINE



Our in-line drilling machine is perfectly suited for unmanned operations in flat glass mass production facilities. It seamlessly integrates with other equipment via a built-in transport table, offering the following key features:

High-Speed Servo Drilling System

Imported from Germany for precise and reliable drilling operations.

Glass Waste Discharge System

Automatically gathers glass waste into designated container.

Advanced Automation Functions

Enhance operational efficiency, minimize equipment downtime, and reduce maintenance efforts.



SPECIFICATION

Glass thickness:	2-25mm
Minimal glass size:	300(W) x 350mm(L)
Maximal glass size:	1200(W) x 2500mm(L)
Hole size:	φ 4-65mm
Tolerance of hole size:	± 0.2mm
Tolerance of hole position:	± 0.3mm
Drilling cycle:	10-30s

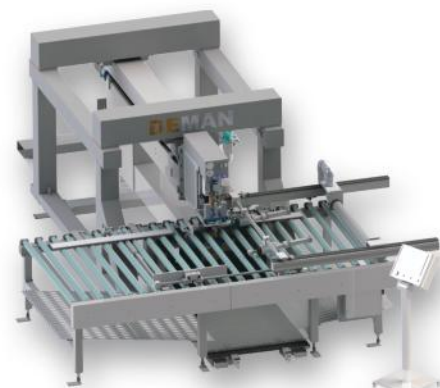

AUTOMATIC IN-PARALLEL DRILLING MACHINE

This machine is specifically engineered for customers with high production capacity needs. A standout feature is its ability to connect multiple units in parallel to a single conveyor table, facilitating seamless integration with other in-line equipment and achieving unprecedented drilling speeds. Additional features include:

Three-Sided Glass Positioning System

Ensures precision during high-speed operations.

Automatic Drill Bit Sharpening

Minimizes manual labor by keeping drill bits sharp.

Indirect Drill Motor Connection

Prevents water ingress, enhancing motor longevity.

Versatile Configurations

Available in single-head, 4-head, or 8-head setups to suit various production requirements.

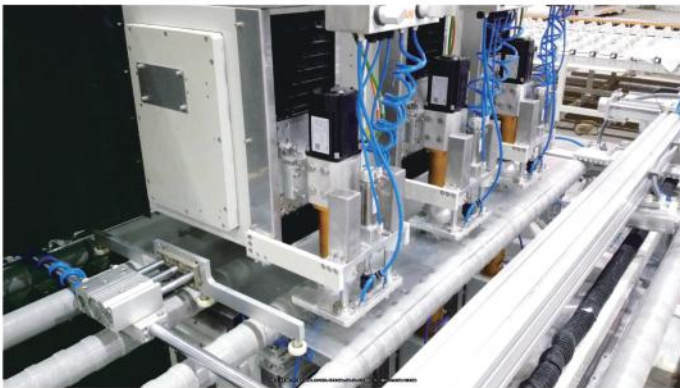

SPECIFICATION

Glass thickness:	3-25mm
Minimal glass size:	300(W) x 350mm(L)
Maximal glass size:	1200(W) x 2500mm(L)
Hole size:	φ 4-65mm
Tolerance of hole size:	± 0.2mm
Tolerance of hole position:	± 0.3mm
Drilling cycle:	10-30s

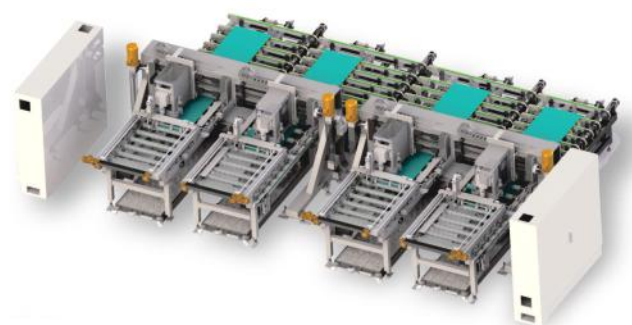

AUTOMATIC IN-LINE DRILLING & MILLING MACHINE



This automatic in-line drilling and milling machine is engineered for high precision and versatility in glass processing, enabling multiple operations to be performed on a single machine. It is an ideal solution for production facilities where efficient space usage is paramount. Key features of this machine include:

Multi-Tool Processing

Capable of accommodating up to 8 sets of drills, milling cutters, or internal grinding wheels simultaneously, allowing for diverse processing scenarios.

High-Speed Servo Drilling System

Imported from Germany, ensuring exceptional precision and cleanliness in drilling operations.

Automatic Waste Discharge System

Efficiently transfers glass waste into designated container, enhancing operational efficiency and reducing equipment failure rates and maintenance.

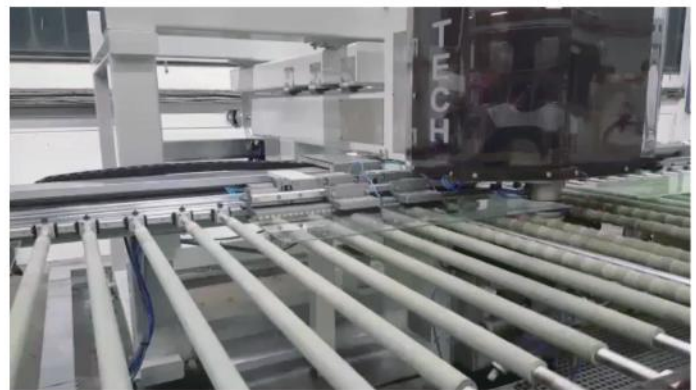
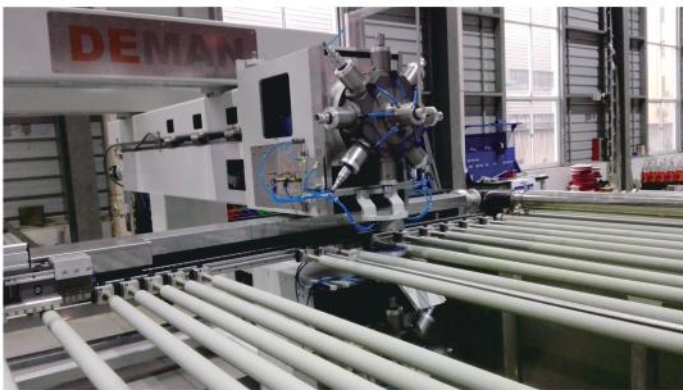

SPECIFICATION

Glass thickness:	2-25mm
Minimal glass size:	300(W) x 350mm(L)
Maximal glass size:	1200(W) x 2500mm(L)
Hole size:	φ 4-65mm
Tolerance of hole size:	± 0.2mm
Tolerance of hole position:	± 0.3mm
Drilling cycle:	10-30s

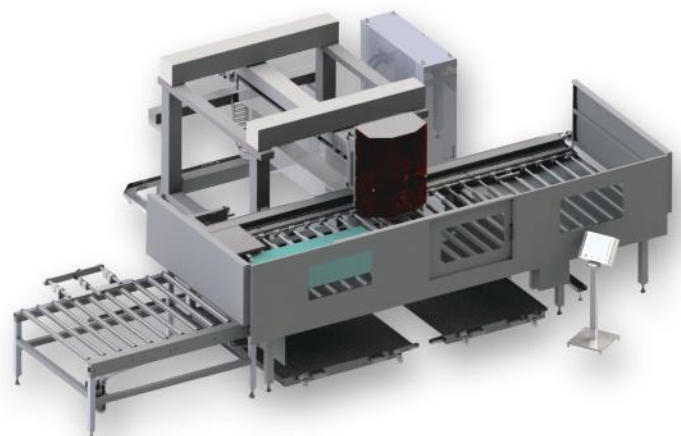

AUTOMATIC IN-LINE VACUUM DRILLING MACHINE

Introducing our state-of-the-art vacuum drilling machine, specifically designed for the electronics industry. This advanced machine offers several key features:

Minimal Cooling Water Usage

Uses a small amount of water to cool the drill bit, enhancing drilling accuracy while keeping the glass surface free from water and processing residues.

Efficient Vacuum System

Collects water and glass powder during drilling, filters it, and recirculates it in the next drilling cycle, eliminating the need for constant refilling and disposal.

Sustainable Operation

Reduces waste and saves resources by recycling water, providing a sustainable solution for glass drilling.

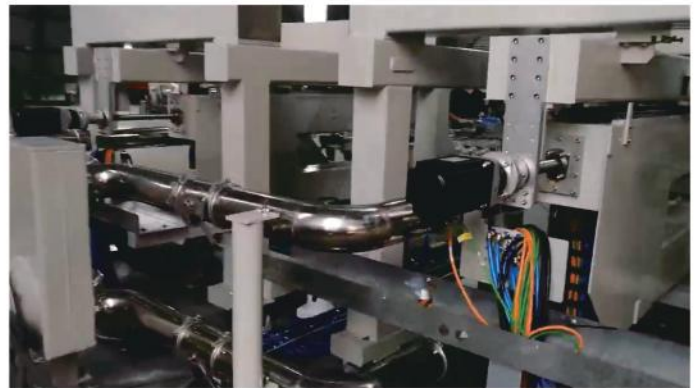

SPECIFICATION

Glass thickness:	1-25mm
Minimal glass size:	150(W) x 100mm(L)
Maximal glass size:	3600(W) x 2500mm(L)
Hole size:	φ 4-65mm
Tolerance of hole size:	± 0.2mm
Tolerance of hole position:	± 0.3mm
Drilling cycle:	10-30s

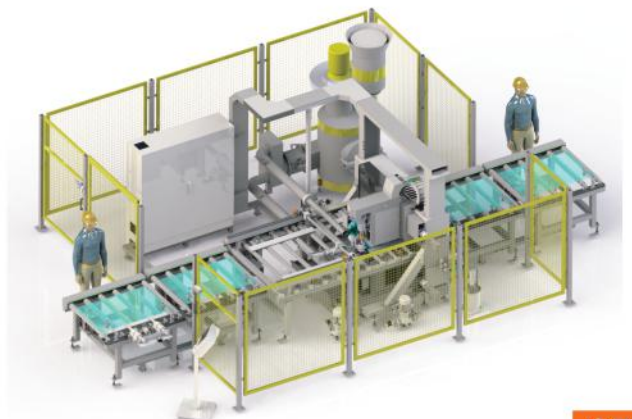

FULLY AUTOMATIC IN-LINE HEAVY-DUTY DRILLING MACHINE



This heavy-duty drilling machine excels in processing large to jumbo-sized flat glass, and offers advanced features that ensure high productivity and precise performance, specifically catering to the rigorous demands of large-sized glass processing:

Revolver Drilling Heads

Available with 4 or 8 upper and lower drilling spindles, that can accommodate drills, milling cutters, or internal grinding wheels simultaneously.

High-Speed Servo Drilling System

Imported from Germany, it ensures high yield, precision, and cleanliness in drilling operations.

Automatic Waste Discharge System

Efficiently disposes of waste material into designated container, improving operational efficiency, reducing equipment failure rates, and minimizing maintenance time.

Adaptable Single-Piece Processing

Ideal for processing large glass pieces with varying hole positions and diameters, or utilizing various processing techniques.

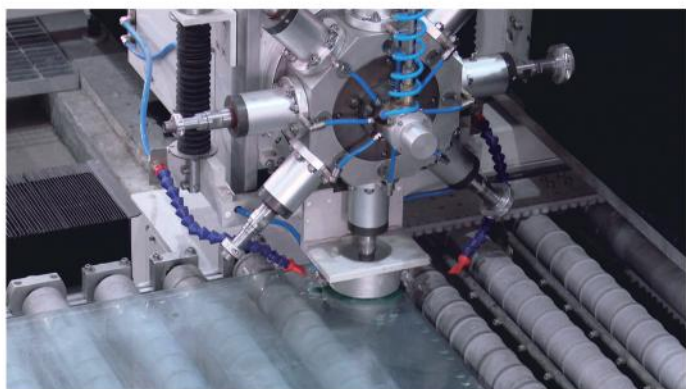

SPECIFICATION

Glass thickness:	3-25mm
Minimal glass size:	300(W) x 350mm(L)
Maximal glass size:	1200(W) x 2500mm(L)
Hole size:	φ 4-65mm
Tolerance of hole size:	± 0.2mm
Tolerance of hole position:	± 0.3mm
Drilling cycle:	10-30s





FULLY AUTOMATIC IN-LINE HEAVY-DUTY CNC MACHINE

Designed with a specialized transmission system that is fully waterproof, this fully automatic CNC machine excels in handling large-sized glass processing tasks. This versatile equipment seamlessly integrates drilling, milling, inner circle grinding, and outer edge grinding functions, offering several standout features:

Optional Waterjet Cutting Function

Provides additional versatility for specific processing needs.

Automatic Tool Changing System

Facilitates seamless and rapid transitions between different tools, optimizing workflow and operational efficiency.

Robust Water Treatment System

Equipped with a high-pressure pump from the United States, ensuring long-term stability and reliability.

Automatic Waste Discharge System

Efficiently collects glass waste into designated containers, minimizing equipment downtime and maintenance efforts.

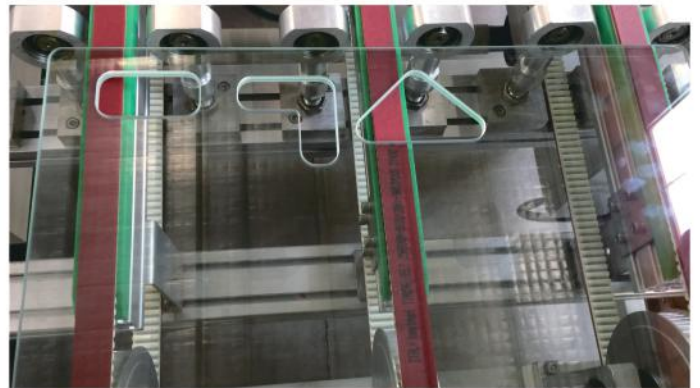

SPECIFICATION

Glass thickness:	3-25mm
Minimal glass size:	500(W) x 500mm(L)
Maximal glass size:	2000(W) x 1000mm(L)
Hole size:	φ 4-65mm
Tolerance of hole size:	± 0.2mm
Tolerance of hole position:	± 0.3mm
Drilling cycle:	10-30s

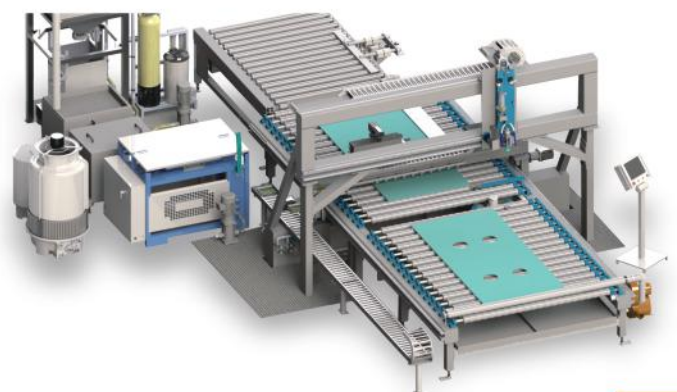

HORIZONTAL WASHING MACHINES



DEMAN



PHOTOVOLTAIC GLASS WASHING MACHINE

The photovoltaic glass washing machine is designed for use during the production process of solar glass. When used for cooling, it operates without brushes and utilizes ventilators to cool the glass efficiently. For washing, it can be equipped with specialized brushes to ensure the glass surface is clean from residues.



SPECIFICATION

Speed:	0-65m/min
Glass thickness:	1.6-4mm
Minimal glass size:	500(W) x 500mm(L)
Maximal glass size:	2650(W) x 1400mm(L)

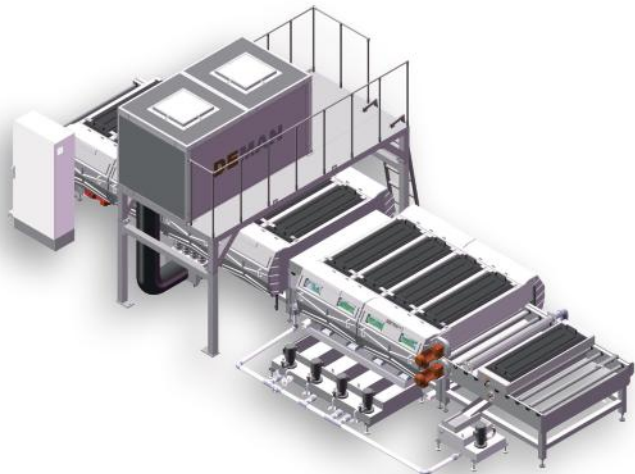

ARCHITECTURAL GLASS WASHING MACHINE

The architectural glass washing machine is equipped with either normal or soft low-e brushes. Its working width and length can be customized to meet the maximum glass size requirements. This machine is designed to deliver exceptional cleaning performance, maintaining the pristine quality of architectural glass throughout the production process.



SPECIFICATION

Speed:	0-15m/min
Glass thickness:	2-25mm
Minimal glass size:	300(W) x 300mm(L)
Maximal glass size:	3200(W) x 2500mm(L)

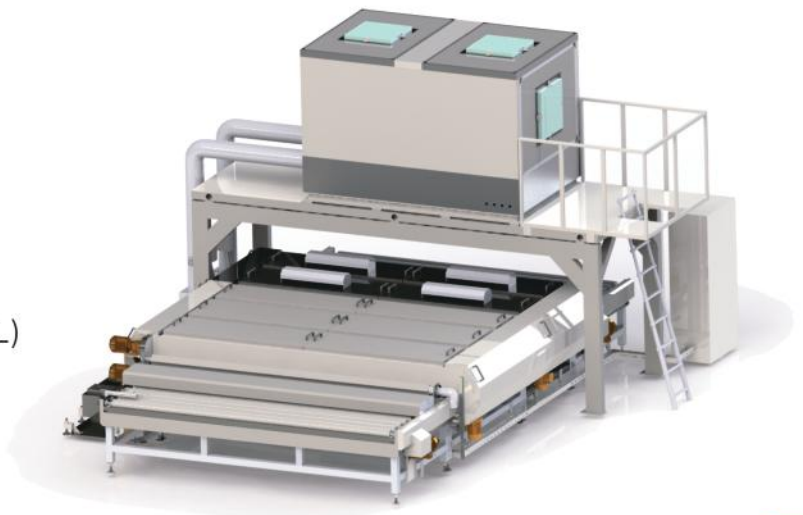

PATTERNED GLASS ACID ETCHING MACHINE

The glass acid etching machine is engineered to create intricate frosted patterns on glass surfaces. With advanced acid etching technology and a high degree of automation, it provides an ideal solution for manufacturers of specially patterned glass. This machine is perfect for producing high-quality, decorative architectural and home appliance glass, as well as for various other applications.

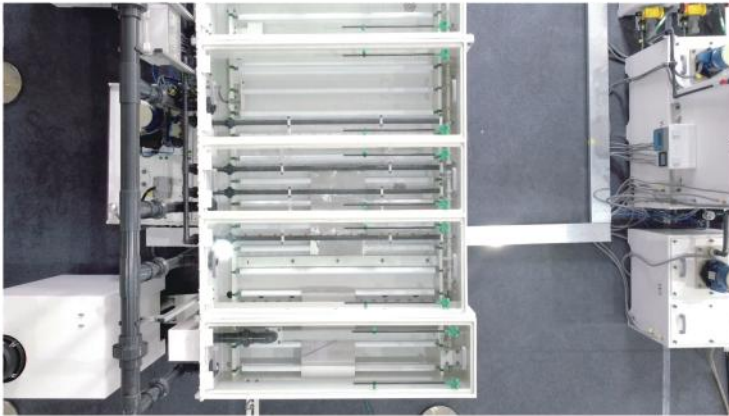

SPECIFICATION

Speed:	0-24m/min
Glass thickness:	2-25mm
Minimal glass size:	300(W) x 300mm(L)
Maximal glass size:	3200(W) x 2500mm(L)



WATER CIRCULATION TREATMENT SYSTEM

Our water purification system combines water supply, parallel circulation filtration, and brush cleaning functions, making it ideal for diverse glass processing facilities. This fully automatic system includes an automatic backwashing design for pretreatment and sensors that protect against water shortage and overpressure. For precise monitoring, flow and conductivity are displayed automatically. Additionally, the system features an automatic water replenishment system and a liquid level display for optimal functionality.



NEW GENERATION WASHING MACHINE



This washing machine represents a leap forward in efficiency and sustainability with its advanced automation and energy-saving features. Equipped with specialized motors and an intelligent energy management system, it operates with minimal energy consumption, reducing environmental impact and operational costs. The drying area is ingeniously housed within a silencing enclosure, effectively minimizing noise during operation. Built for reliability and performance, it meets the high standards demanded by modern glass manufacturing facilities.

SPECIFICATION

Speed:	0-65m/min
Glass thickness:	2-25mm
Minimal glass size:	300(W) x 300mm(L)
Maximal glass size:	3200(W) x 2500mm(L)

Energy saving -40% compared to normal machine

Designed with enhanced noise reduction

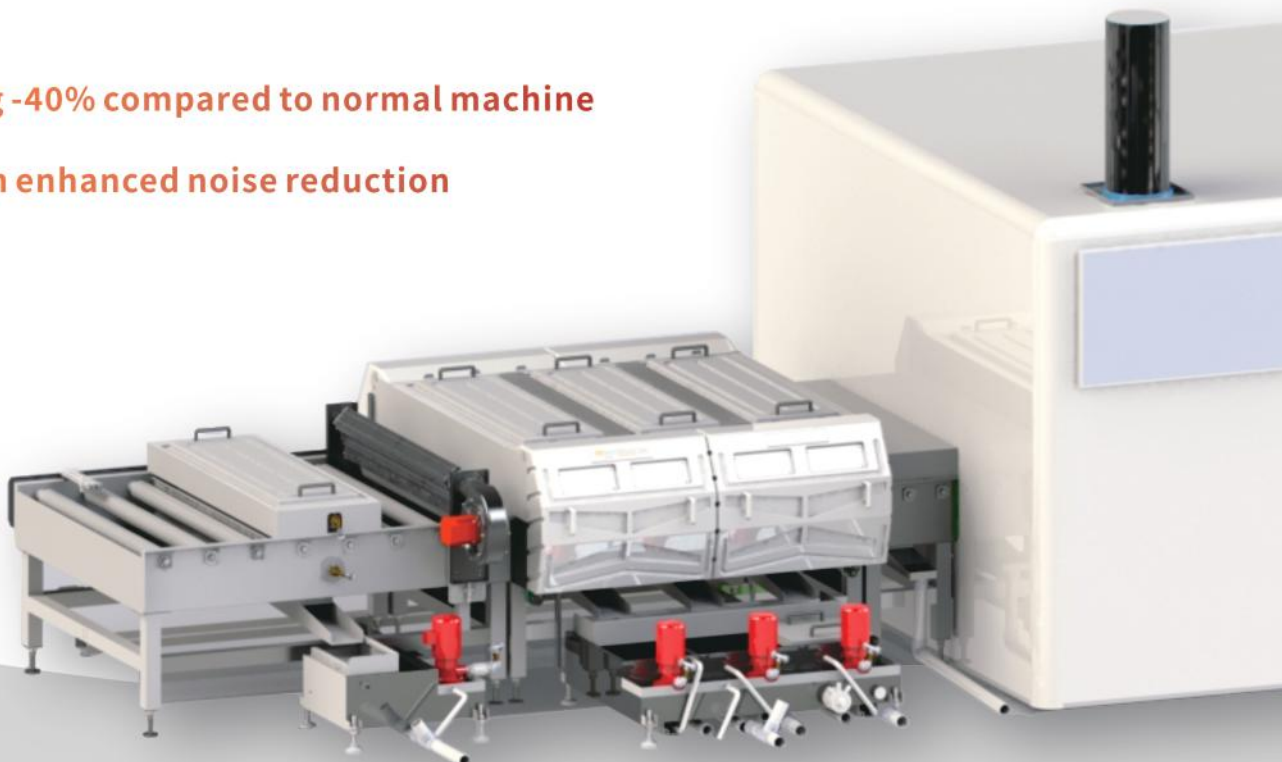



EFFICIENT CLEANING

Incorporating multiple cleaning stages, including pre-washing, washing and drying, the machine ensures thorough cleaning and eliminates any residue or streaks effectively. Each stage is optimized to deliver optimal results while minimizing water and energy consumption.

EFFORTLESS MAINTENANCE

Built with a combination of carefully selected materials, strategically chosen to facilitate effortless maintenance, streamline cleaning procedures, and enhance overall operational efficiency, durability, and corrosion resistance.

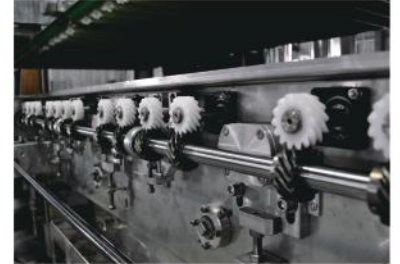

INTUITIVE CONTROL

With an intuitive control panel and user-friendly interface, operating the machine is simple and hassle-free. Operators can easily adjust cleaning parameters, monitor the progress, and troubleshoot any issues efficiently, thereby maximizing productivity.



VERTICAL PROCESSING MACHINES





Vertikal F8

Technologie

VERTICAL GRINDING MACHINE

This machine is ideal for flat glass seaming, grinding, and polishing. It features specially designed spindles made from cast iron and coupled with reliable motors for long-term stable operation. The number of spindles can be customized to meet customer requirements, ensuring flexibility and efficiency in glass processing.

SPECIFICATION

Speed: 1-6m/min
Glass thickness: 3-25mm
Minimal glass size: 600(H) x 300mm(L)

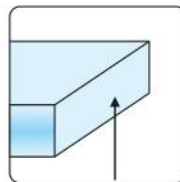

Seamed

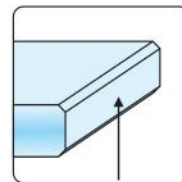

Flat-Grinded

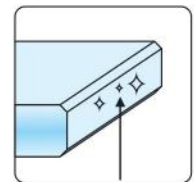

Flat-Polished

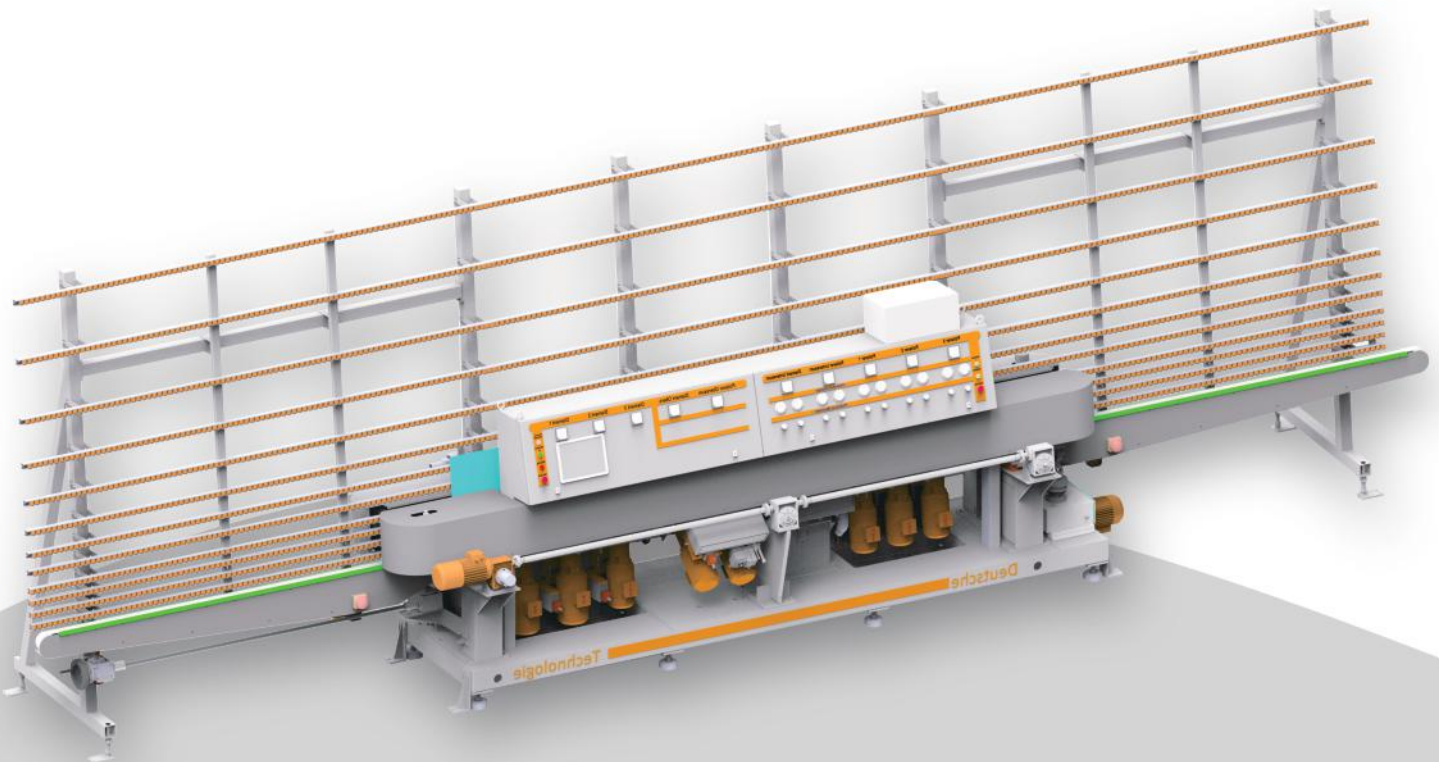

VERTICAL SEAMING MACHINE

Our vertical glass arissing machine is renowned for its exceptional speed and precision. It features an intuitive system that seamlessly handles glass of various sizes, eliminating micro cracks along the entire perimeter. This machine enhances edge integrity and significantly improves the durability and safety of glass pieces during further production processes.

SPECIFICATION

Speed: 1-6m/min
Glass thickness: 3-25mm
Minimal glass size: 600(H) x 300mm(L)

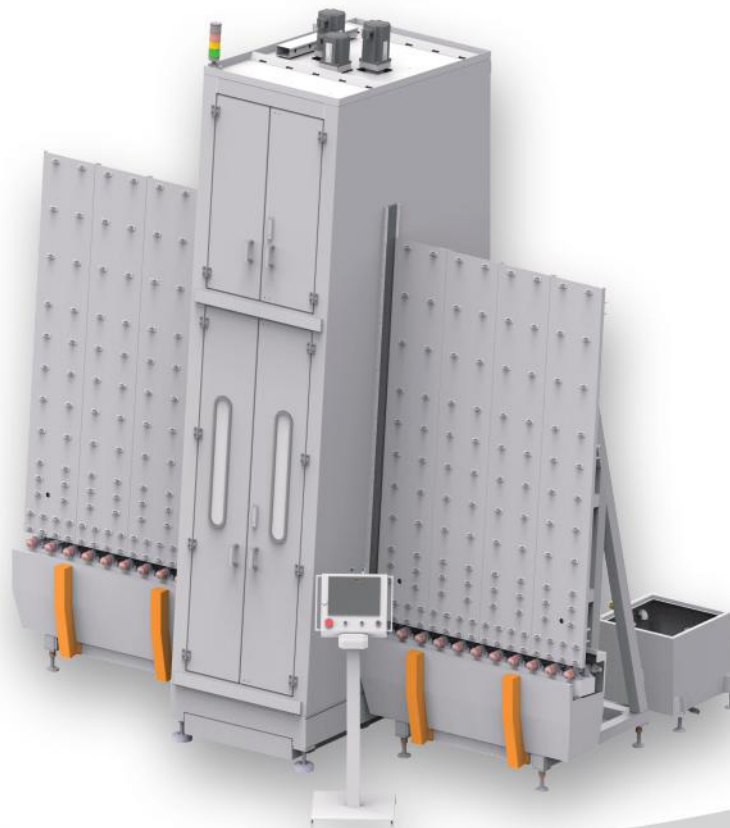
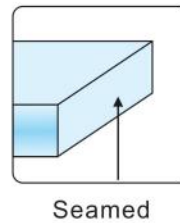

VERTICAL DRILLING MACHINE

The vertical flat glass drilling machine is designed for precision drilling and can be equipped with 1 to 4 pairs of drilling heads or one pair of revolver heads featuring 4 or 8 drilling spindles. It includes a specialized sensor position system that ensures high drilling accuracy. This machine is ideal for efficiently handling a variety of drilling tasks on flat glass surfaces. Its flexible configuration allows for customization to meet specific production requirements.

SPECIFICATION

Glass thickness:	3-25mm
Minimal glass size:	600(H) x 350mm(L)
Maximal glass size:	1200(H) x 2500mm(L)
Hole size:	φ 4-65mm
Tolerance of hole size:	± 0.2mm
Tolerance of hole position:	± 0.3mm
Drilling cycle:	10-30s

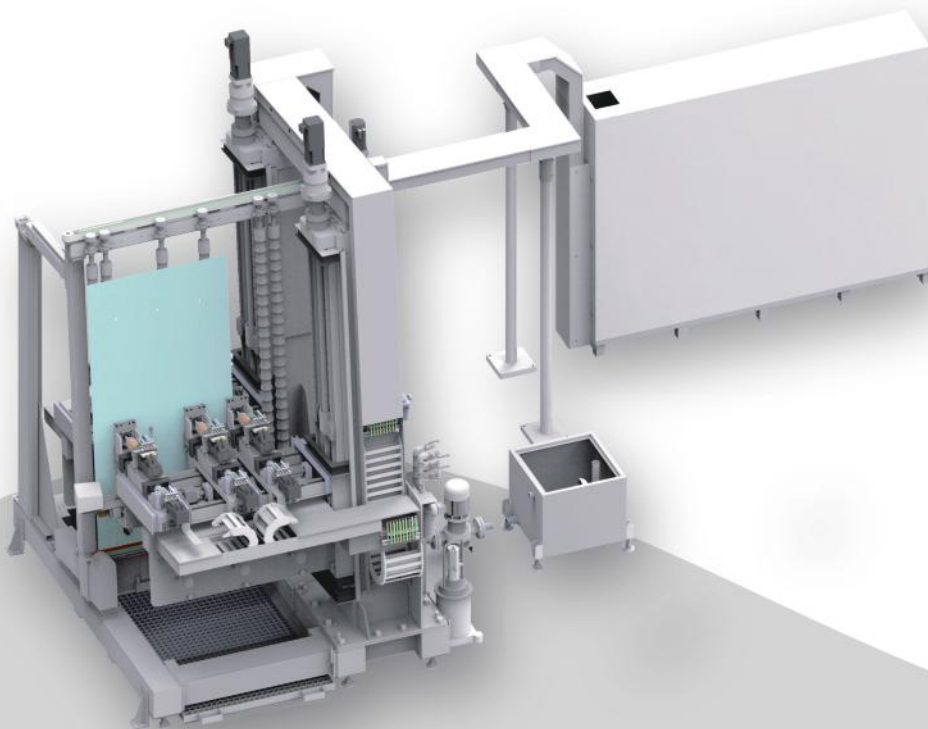

VERTICAL CNC MACHINE

The vertical flat glass CNC machine is equipped with a tool changer system that can accommodate up to 8 sets of drilling, milling, and internal grinding tools. It offers optional integration with a waterjet system for precise glass cutting capabilities. This versatile machine ensures efficient and accurate processing of flat glass. Ideal for complex and varied glasswork tasks, it provides flexibility and high precision in one robust system.

SPECIFICATION

Glass thickness:	3-25mm
Minimal glass size:	600(H) x 350mm(L)
Maximal glass size:	1200(H) x 2500mm(L)
Hole size:	φ 4-65mm
Tolerance of hole size:	± 0.2mm
Tolerance of hole position:	± 0.3mm
Drilling cycle:	10-30s

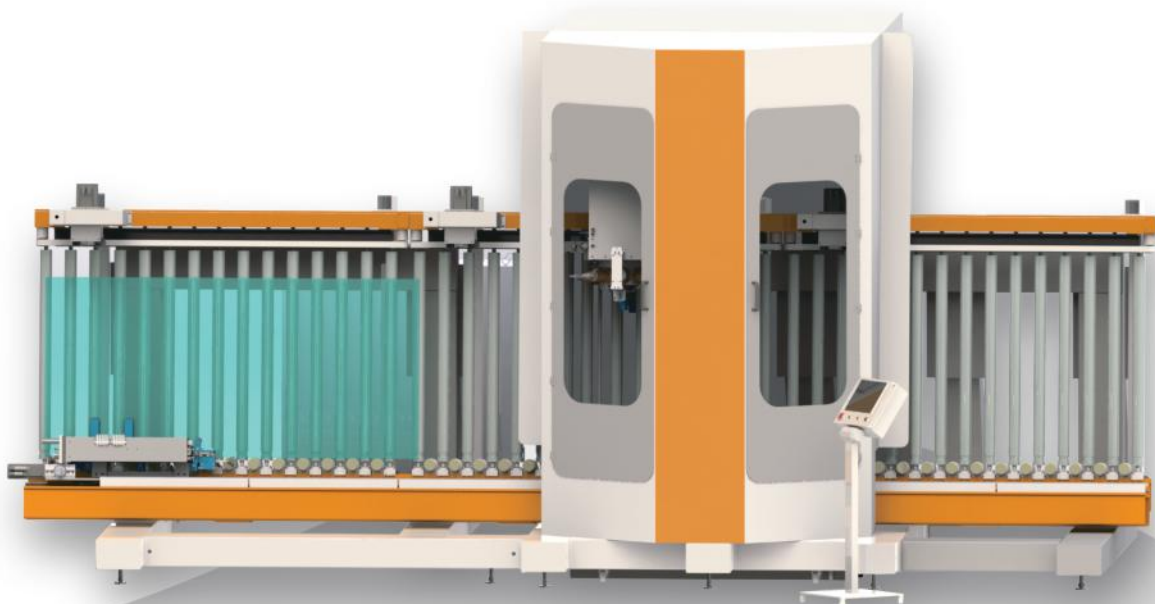

VERTICAL WASHING MACHINE

The vertical glass washing machine is a customizable solution tailored to customer requirements, adaptable for various production processes. It can function as a cooling machine or be equipped with standard, LOW-E, PVA, or other specialized brushes to clean the glass surface. This versatility ensures it meets the specific needs of different glass manufacturing stages.

SPECIFICATION

Speed:	0-10m/min
Glass thickness:	2-25mm
Minimal glass size:	300(H) x 300mm(L)
Maximal glass size:	3200(H) x 2500mm(L)

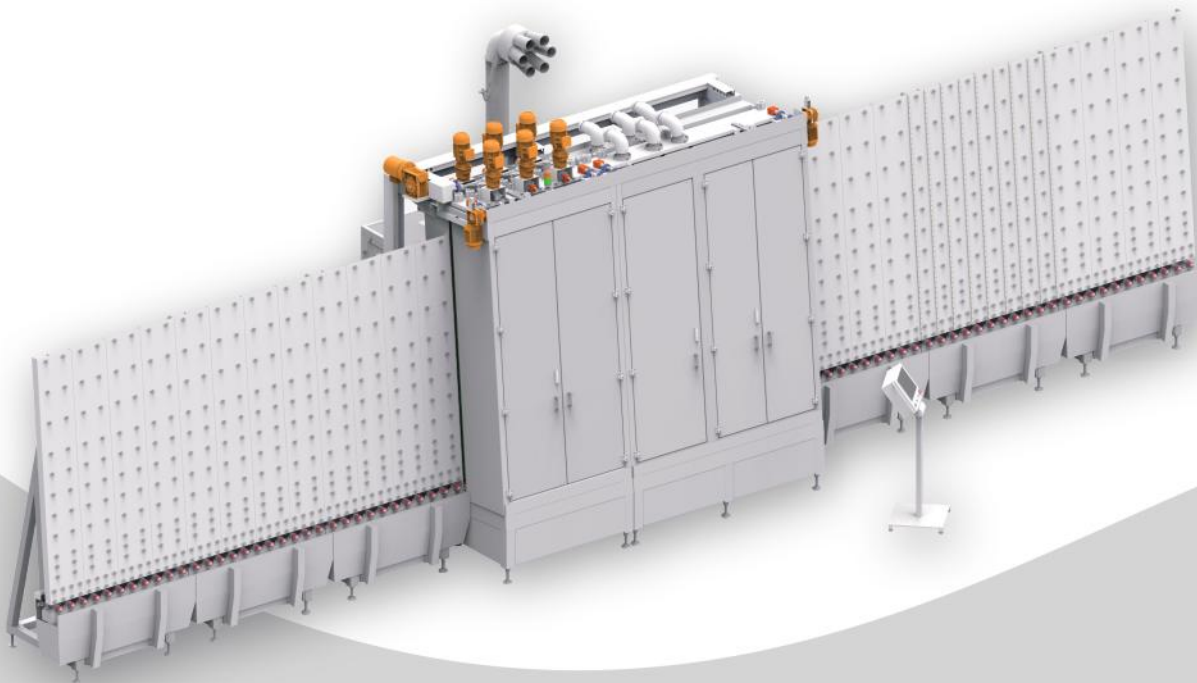

VERTICAL TURNING TABLE

This vertical turning table can seamlessly connect with any other vertical processing machines, enhancing workflow efficiency. Its smart design simplifies glass processing and saves up to 50% of floor space. The table can be customized to match your glass size, making it ideal for optimizing space and streamlining glass manufacturing processes.

SPECIFICATION

Speed:	up to 15m/min
Minimal glass size:	600(H) x 300mm(L)
Maximal glass size:	4200(H) x 2500mm(L)

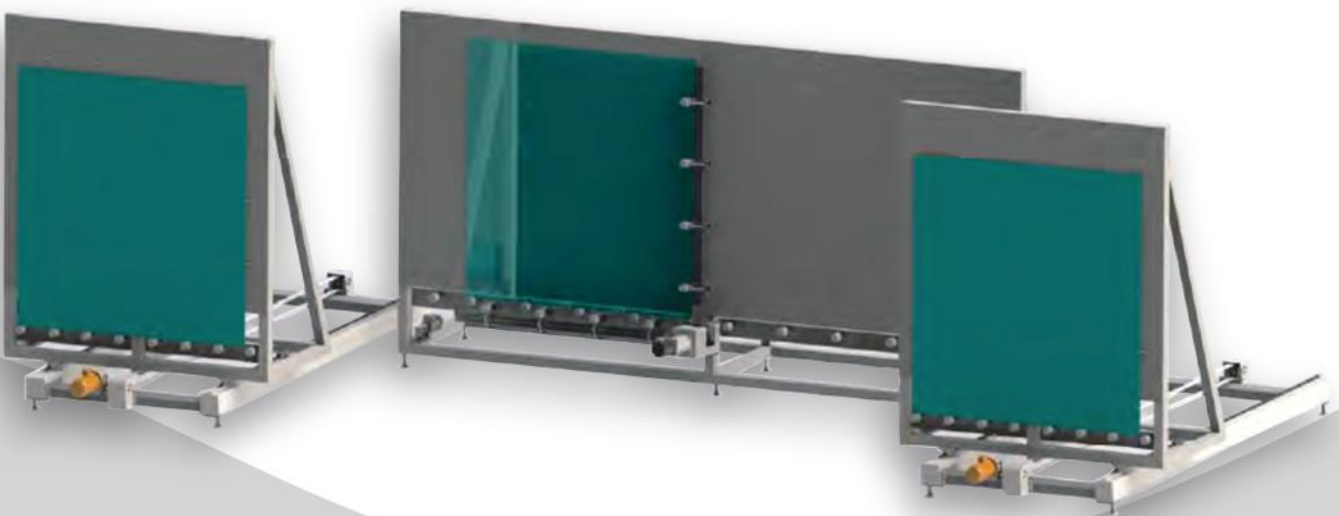

GLASS CONVEYING & HANDLING





AUTOMATIC TRANSPORT SYSTEM

The flat glass automatic transport system is designed for efficient and seamless movement of glass pieces between different processing machines. It features straight motion, rotary, and other transport tables, all equipped with sensors to ensure a high level of automation and precision. The entire transport system can be customized to meet specific customer requirements, enhancing productivity by facilitating smooth transitions throughout the glass processing stages. This tailored approach ensures optimal performance and integration within any glass manufacturing facility.

SPECIFICATION

Speed:	1-6m/min
Glass thickness:	3-25mm
Minimal glass size:	600(H) x 300mm(L)





ROBOTIC LOADER/UNLOADER

Our flat glass robotic loader/unloader is an advanced solution designed to automate the loading and unloading of glass panels in manufacturing facilities. This system uses precision robotics to handle glass pieces with utmost care, reducing the risk of damage and increasing operational efficiency. It can be customized to accommodate various glass sizes and production line configurations. The robotic loader/unloader enhances productivity by streamlining the workflow, minimizing manual handling, and ensuring consistent and reliable operation.

SPECIFICATION

- Glass thickness: 2-25mm
- Minimal glass size: 300(W) x 200mm(L)
- Maximal glass size: 4500(W) x 3200mm(L)

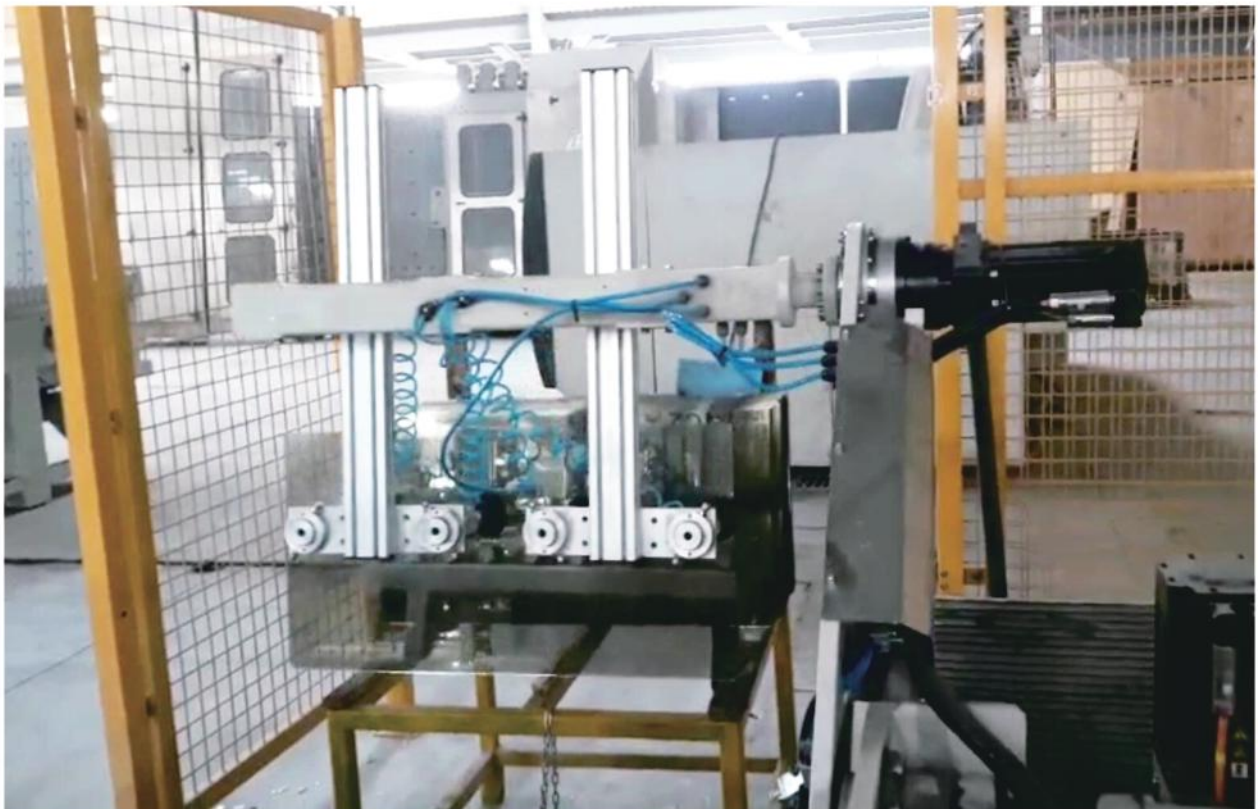

AUTOMATIC GANTRY LOADER/UNLOADER

Introducing the automatic gantry-type loader/unloader, available in 3- or 4-column configurations, designed to optimize the efficiency of glass manufacturing operations. This system offers robust and precise handling of glass pieces, reducing the need for manual labor and minimizing the risk of damage. Its automated functions ensure smooth loading and unloading processes, enhancing overall productivity. Customizable to meet various production requirements, the gantry-type loader/unloader provides consistent and reliable performance, making it an essential asset for any modern glass processing facility.

SPECIFICATION

- Glass thickness: 2-25mm
- Minimal glass size: 300(W) x 200mm(L) (2pcs./time)
- Maximal glass size: 4500(W) x 3200mm(L)



AUTOMATIC TURNOVER LOADER/UNLOADER

The tilt turnover-type automatic glass loader/unloader is an essential part of the flat glass production line. It handles the glass panels with precision and care, automating the process to reduce manual labor and minimize the risk of damage. This turnover table can also connect vertical and horizontal processing machines, enhancing workflow efficiency and ensuring seamless integration within glass manufacturing operations.

SPECIFICATION

- Glass thickness: 2-19mm
- Minimal glass size: 1000(W) x 1000mm(L)
- Maximal glass size: 3300(W) x 18000mm(L)



PRODUCTION LINE

We can automate the conveying of glass through different processing sections such as edging, washing and tempering, set up and coordinate the automation work of different machines of the entire production line. Our custom-made solution can improve the automation and mass production efficiency, save labor costs and reduce the loss caused by manual handling.

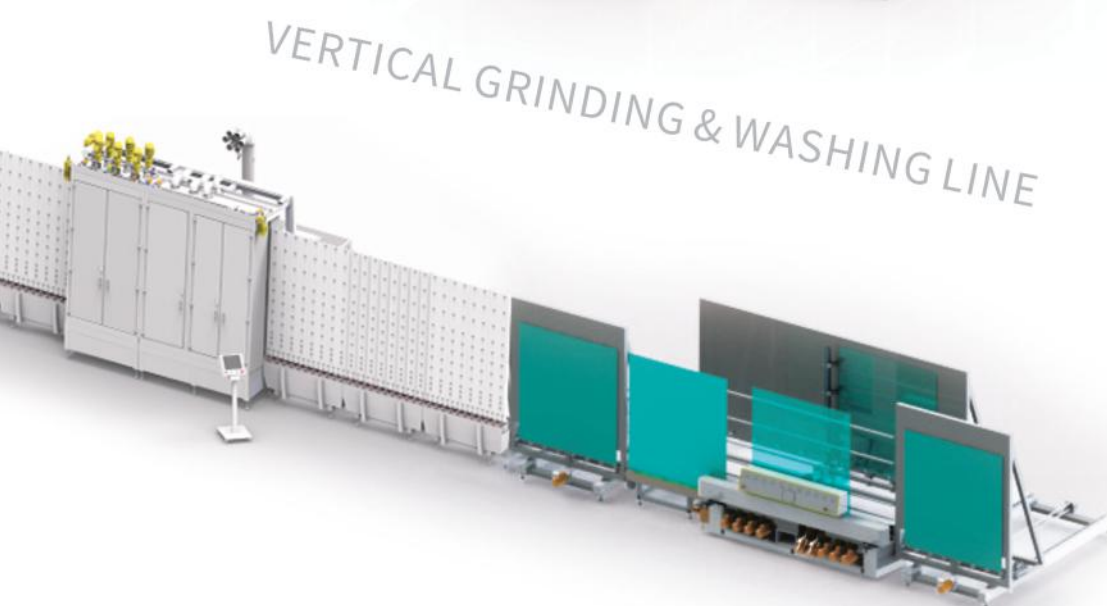
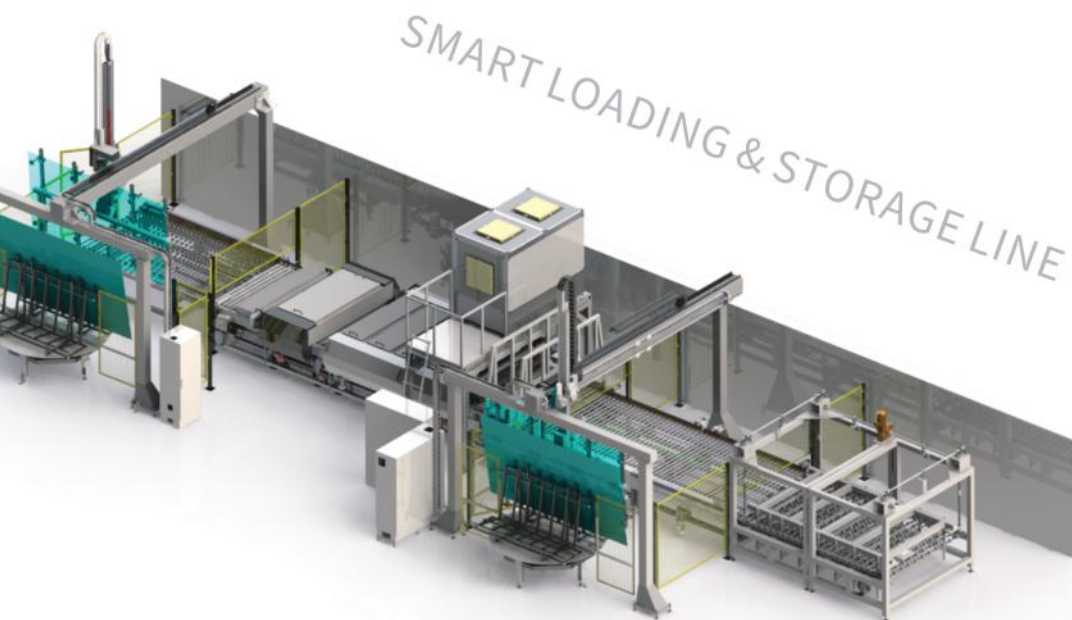

PRODUCTION LINE FORM

The production line can accommodate both horizontal and vertical glass processing equipment, offering flexibility in configuration with options such as straight, L-type, or U-type layouts. These configurations can be adjusted to optimize the use of available space, ensuring efficient operation in glass manufacturing facilities.

STRAIGHT ALIGNED LINE

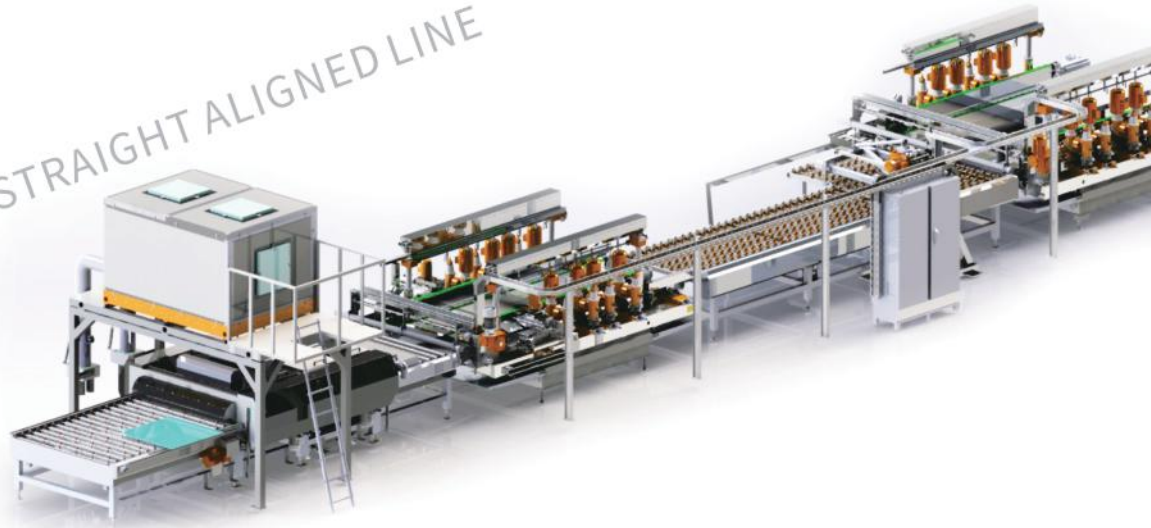

U-SHAPE ALIGNED LINE

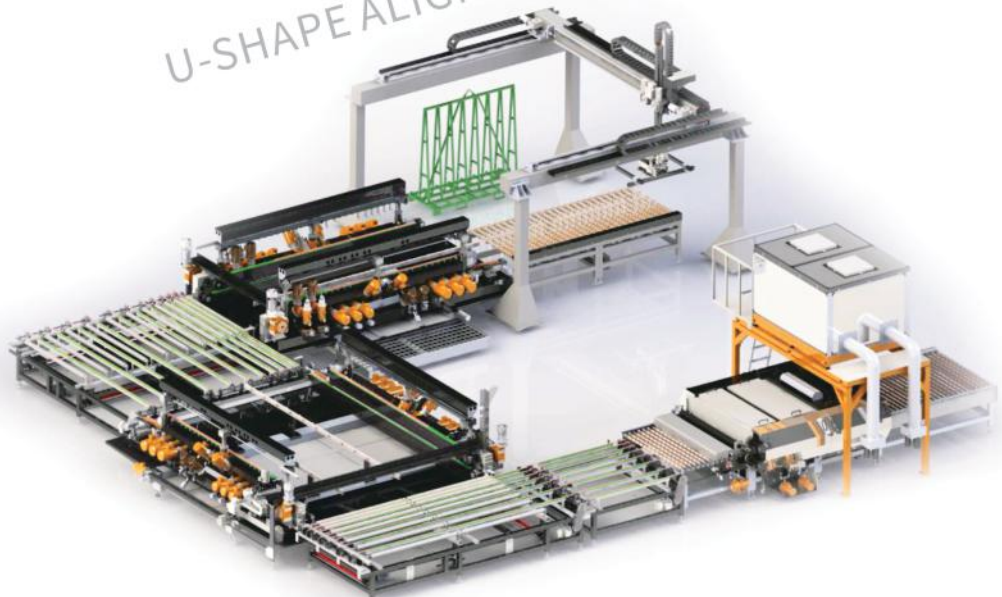

DEMAN

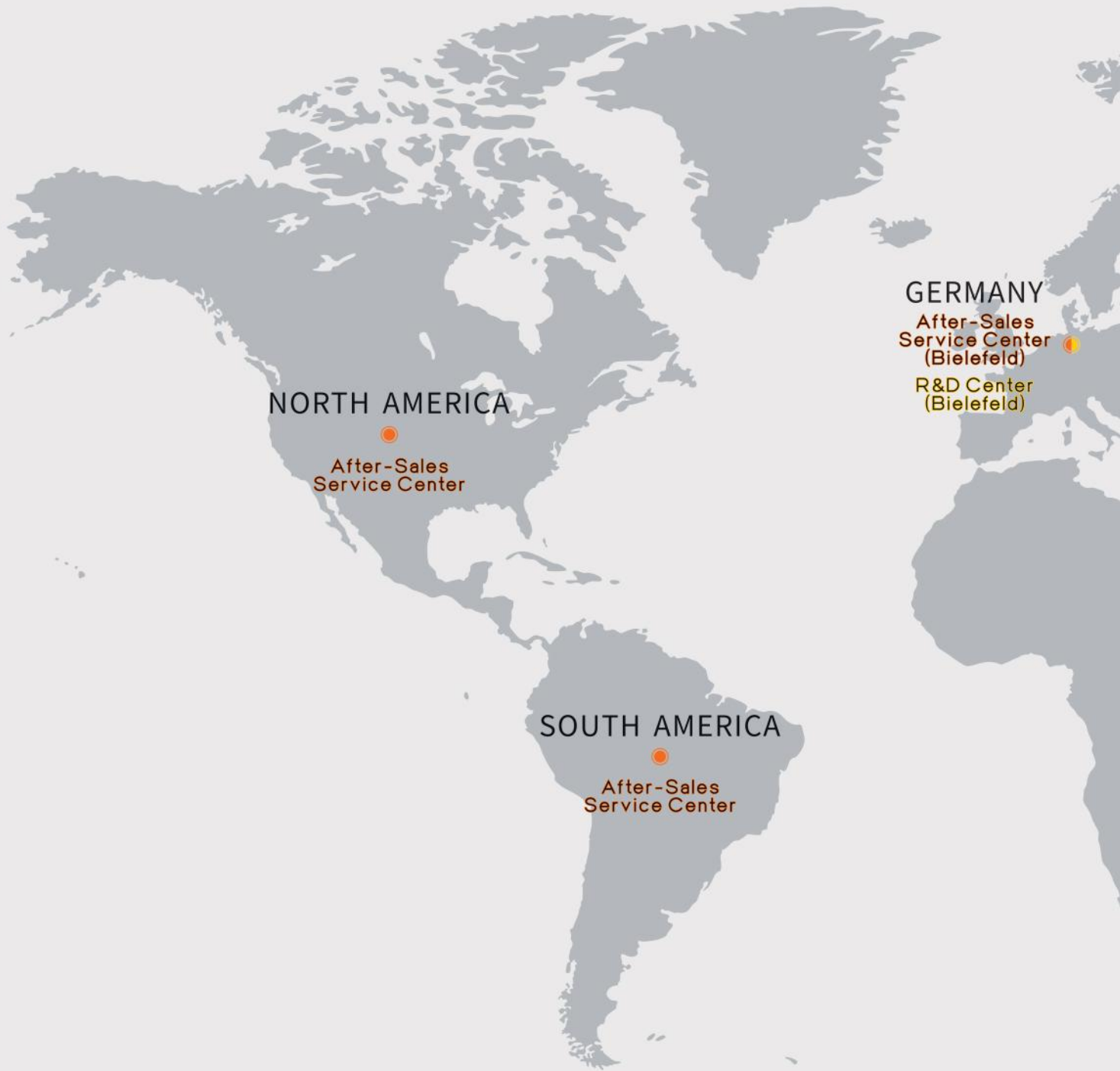

NORTH AMERICA

After-Sales
Service Center

SOUTH AMERICA

After-Sales
Service Center

GERMANY

After-Sales
Service Center
(Bielefeld)

R&D Center
(Bielefeld)



RUSSIA

After-Sales
Service Center

CHINA

R&D Center
(Changzhou)

Headquarters
(Hangzhou)

INDIA

After-Sales
Service Center

MIDDLE EAST

After-Sales
Service Center

MALAYSIA

After-Sales
Service Center



The images and data in this catalogue are provided for reference purposes only, as our machines are custom-produced to meet specific customer requirements. For detailed information, please reach out to our sales team.

This brochure is protected by copyright, and all rights are reserved. Any use or reproduction of its contents is strictly prohibited without permission from DEMAN.

HEADQUARTERS



No.2 Bei Shan Bei Road, Xin Deng New Industrial Park,
311404 Fuyang, Hangzhou, Zhejiang, China
TEL : +86(0)159-06610400
E-MAIL : florian@fydeman.com
www.zjdeman.com

EUROPEAN BRANCH



Beckheide 1, 33689 Bielefeld, Germany
TEL : +49(0)5205-3073401
E-MAIL : kontakt@deman-europe.de
www.deman-europe.de